

Communication base module CM06



Schneid GesmbH | Gewerbering 16 | A-8054 | Graz/Pirka | Tel: +43 (316) 285022

Products, data sheets, documentation, MR12-SCHEMA-calculator: www.schneid.at

Communication base module CM06

for SCHNEID module controller MR03, 07, 08 *, 12 * (MR08 after 2013 and MR12 only with adapter cable)

Order number: 130.09471

Order code: SCHNEID Kommunikationsbasismodul CM06

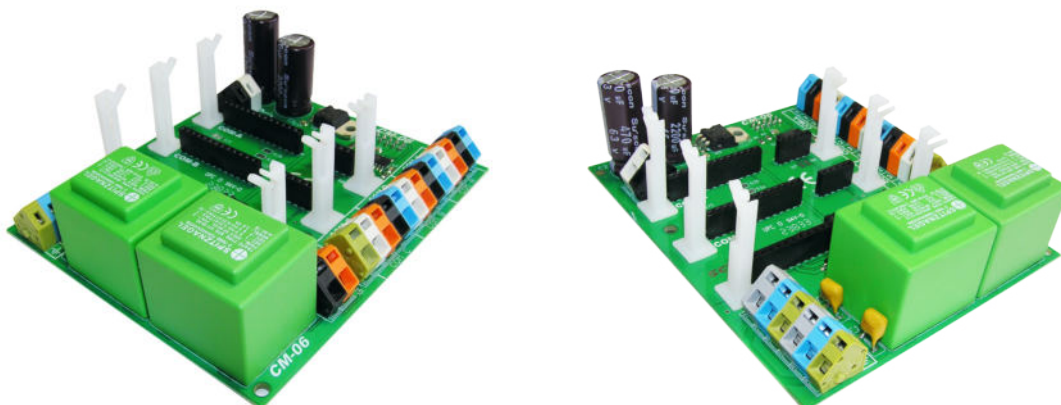

Overview:

With the SCHNEID communication base module CM06, the base module controller can be equipped with up to three bus interfaces:

1. Standard bus for controller networking and system visualization via SCHNEID-WinMiocs or SinVIS
2. Bus interface for consumption data acquisition (e.g. Meter)
3. Internal controller bus for control networking (SubCOM)

A corresponding bus module can be fitted for each of the three bus interfaces, depending on the application. The following bus modules are available:

- RS232 bus module	- TCP/IP Ethernet bus module
- RS485 bus module	- BT (Bluetooth) radio module
- RS422 bus module	- RF (RadioFrequency) radio module
- MBUS-Master bus module	- GPRS module
- MBUS-Slave bus module	- MP-Bus module
- USB bus module	- PGW-Bacnet module

Examples of networking:

COM-A: All data from the control unit and the heat meter are transferred to the host computer in the boiler house via the special interface SCHNEID-FSS (see WINMIOCS and FW-MANAGEMENT).

COM-B: Reading of measurement data from heat meters, electricity meters and other external devices using M-Bus interface (M-Bus protocol according to CEN TC176 WG4 and IEC1107).

Recorded data using the example of a heat meter: amount of heat, flow rate, flow temperature, return temperature, spread, power, flow rate, etc.

Communication base module CM06

COM-C: Various SCHNEID control units can be linked together on the control side via an internal data bus. Corresponding setpoints and the centrally measured outside temperature are exchanged under the control devices to enable optimized control.

Terminal plan:

Supply connections:

	Communication base module CM06	Communication base module CM06 115VAC
L	Supply 230VAC	Supply 115VAC
N	Supply 230VAC	Supply 115VAC
PE		
L	Supply 230VAC	Supply 115VAC
N	Supply 230VAC	Supply 115VAC
PE		
+36V	Output terminal 36VDC	Output terminal 36VDC
0V	GND	GND
+5V	Output terminal 5VDC	Output terminal 5VDC
0V	GND	GND

Interface connections:

Controller connector: 10-pin

There are 3 slots for communication cards on the module.

The slots COM-A, COM-B, COM-C are routed to terminals.

Connections:

COM-A	to terminal A1-A4
COM-B	to terminal B1-B4
COM-C	to terminal C1-C4

Depending on the interface card, terminals 1-3 have different assignments. These are described for the individual cards.

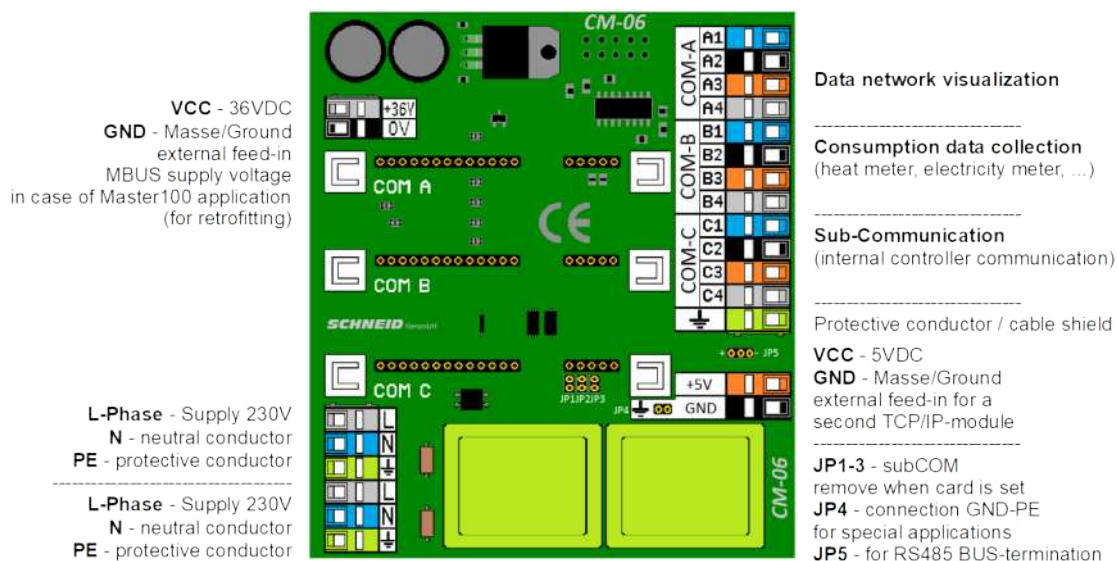

Communication base module CM06

Variants:

SCHNEID communication base module CM06

for SCHNEID Module-controller MR03, 07, 08*, 12* (*adapt cabel necessary)

Order number: 130.09471

Order code: Kommunikationsbasismodul CM06

SCHNEID communication base module CM06 115VAC

for SCHNEID Module-controller MR03, 07, 08*, 12* (*adapt cabel necessary)

Order number: 130.12927

Order code: Kommunikationsbasismodul CM06 115VAC

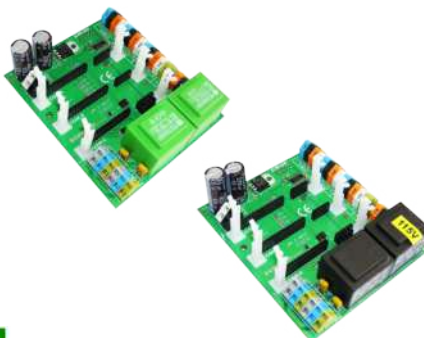

VCC - 36VDC
GND - Masse/Ground external feed-in
MBUS supply voltage in case of Master100 application (for retrofitting)

L-Phase - Supply 115V
N - neutral conductor
PE - protective conductor

L-Phase - Supply 115V
N - neutral conductor
PE - protective conductor

COM A
COM B
COM C

COM-A
A1
A2
A3
A4
COM-B
B1
B2
B3
B4
COM-C
C1
C2
C3
C4
+5V
GND

115 VAC

115 VAC

CM-12

Data network visualization

Consumption data collection (heat meter, electricity meter, ...)

Sub-Communication (internal controller communication)





Protective conductor / cable shield

VCC - 5VDC
GND - Masse/Ground external feed-in for a second TCP/IP-module

JP1-3 - subCOM remove when card is set
JP4 - connection GND-PE for special applications
JP5 - for RS485 BUS-termination

Possible combinations:

With the production date from 06/2013 and from batch C # 22293, the communication connection on the module controller MR08 is changed from 10 to 14 poles. The use of a CM06 communication base module is only possible with an adapter cable (14 to 10-pin). The module controller MR12 also has a 14-pin communication connection.

<p>CM06 - 10-pin</p> 	<p>MR03, MR07, MR08 (vor 2013) - 10-pin</p> 
<p>CM06 - 10-pin</p> 	<p>MR08 (after 2013) and MR12 - 14-pin</p> 
<p style="text-align: center;">Adapter cabel necessary 10 >> 14-pin</p> 	

Communication base module CM06

Scope of delivery:

SCHNEID CM06 communication base module and 10-pin connection cable (800mm).

Technical specifications:

Intrastat number:	8537.10.91.99
Country of origin	no preferential origin
Height, width, depth (in mm)	115x100x44
Weight in (kg)	0,308 (CM06 115VAC: 0,299)
Degree of protection	IP-20
Ambient temperature	0°C....+40°C
Operating voltage	230VAC (CM06 115VAC: 115VAC)
Power consumption	Max. 5VA
Maximum power 5VDC	250mA
Maximum power 36VDC	100mA
Connection type	Fixed wiring terminals
Connection technology	Spring clamp
Cable cross section	Max. 2.5mm ²
Mounting type	DIN-RAIL TS35
Operating time	Continuous operation
Degree of pollution	2
Rated impulse voltage	1kV