

Heating circuit module HK12

Connection diagram:

Outputs 230VAC

- 1P1 Pump of Heating Circuit 1 1
- 1M1 Circuit 1 of Mixed Valve OPEN 2
- 1M1 Circuit 1 of Mixed Valve CLOSED 3

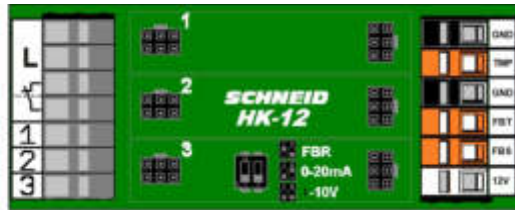

Heating Module Circuit 1

- GND Signalground
- TMP 1T1 Flow Temperature Circuit 1
- GND Remote Control Circuit 1
- FBT Remote Control Room Temperature
- FBS Remote Control Signal
- VCC Remote Control Supply

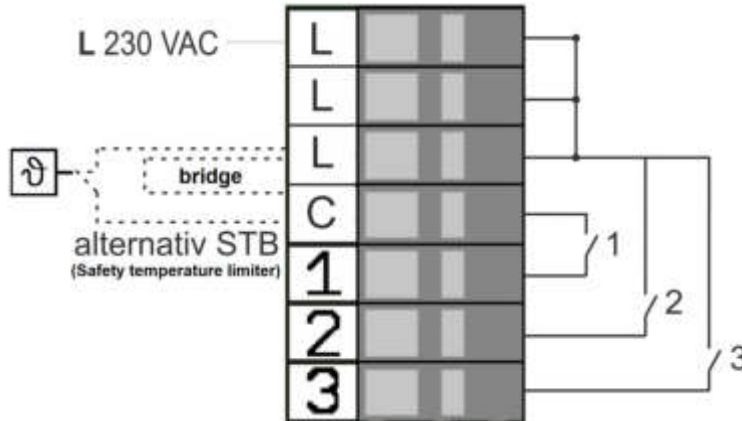

Connections 230V:

- L connection 230VAC
- L additional connection 230VAC (continuation to further module)
- 1 output heating circuit pump
- 2 output heating circuit mixer OPEN
- 3 heating circuit mixer CLOSE output
- N neutral conductor
- PE

Signal connections:

- GND Signalground
- TMP Heating circuit flow temperature sensor

- GND Signalground
- FBT Room temperature sensor
- FBS Remote control signal line
- VCC Remote control supply line

Heating circuit module HK12

Connection diagram:

Outputs 230VAC

- 1P1 Pump of Heating Circuit 1 1
- 1M1 Circuit 1 of Mixed Valve OPEN 2
- 1M1 Circuit 1 of Mixed Valve CLOSED 3

Outputs 230VAC

- 2P1 Pump of Heating Circuit 2 1
- 2M1 Circuit 2 of Mixed Valve OPEN 2
- 2M1 Circuit 2 of Mixed Valve CLOSED 3

Outputs 230VAC

- 3P1 Pump of Heating Circuit 3 1
- 3M1 Circuit 3 of Mixed Valve OPEN 2
- 3M1 Circuit 3 of Mixed Valve CLOSED 3

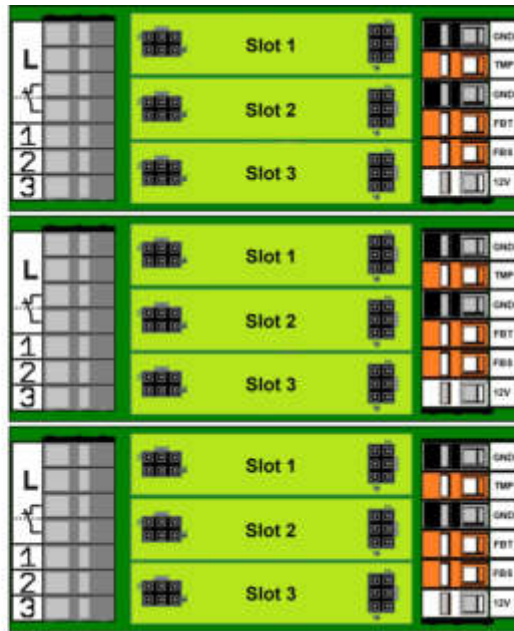

Heating Module Circuit 1

- GND
- TMP 1T1 Flow Temperature Circuit 1
- GND Remote Control Circuit 1
- FBT Remote Control Room Temperature
- FBS Remote Control Signal
- 12V VCC 12VDC

Heating Module Circuit 2

- GND
- TMP 2T1 Flow Temperature Circuit 2
- GND Remote Control Circuit 2
- FBT Remote Control Room Temperature
- FBS Remote Control Signal
- 12V VCC 12VDC

Heating Module Circuit 3

- GND
- TMP 3T1 Flow Temperature Circuit 3
- GND Remote Control Circuit 3
- FBT Remote Control Room Temperature
- FBS Remote Control Signal
- 12V VCC 12VDC

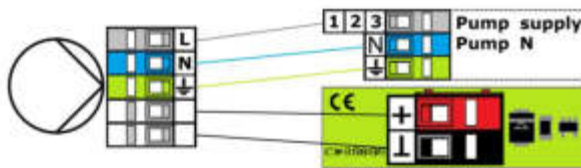

(Excerpt from the AKP-connection sheet)

Slot 1-3
(depending on the configuration required)

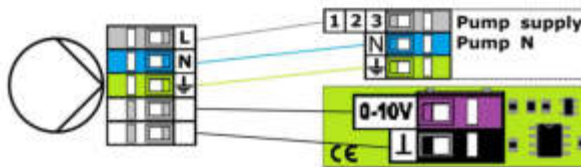

(Excerpt from the AKP-connection sheet)

Slot 1-3
(depending on the configuration required)

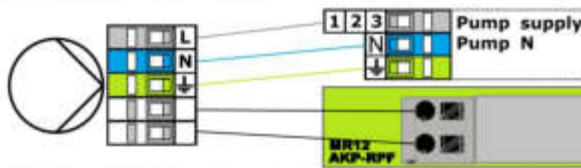

(Excerpt from the AKP-connection sheet)

Slot 1-3
(depending on the configuration required)

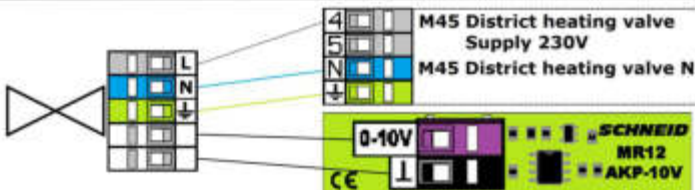

(Excerpt from the AKP-connection sheet)

Slot 4

